

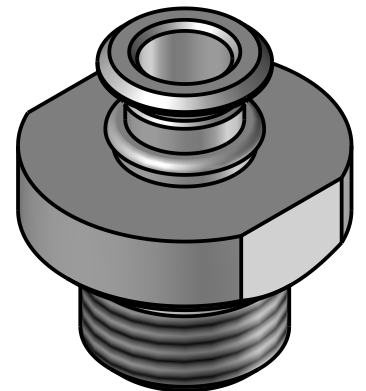

THE PROPERTY OF THE DRAWING IS ESTABLISHED BY LAW. IT IS FORBIDDEN TO PRODUCE OR SHOW IT TO THIRD PART. WITHOUT A WRITTEN AGREEMENT.

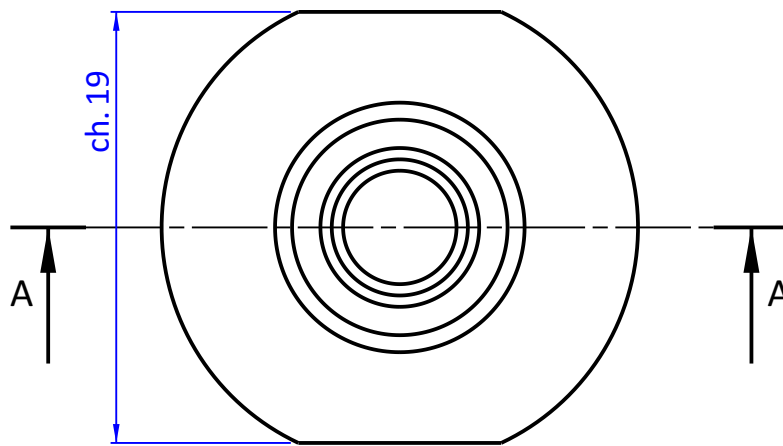
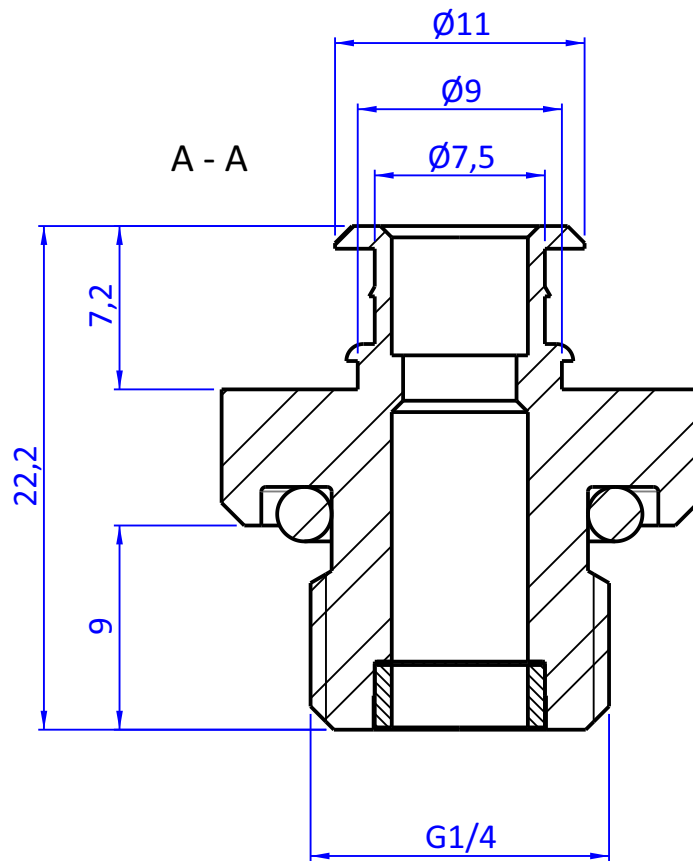
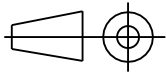

Format A4 UNI 936-76	 FPS SERVICES AUTOMATION			DESIGNED FROM FPS Automation	REVIEW A
	GENERAL TOLERANCE UNI - ISO 2768 CLASSE f	DESCRIPTION CA.08.09.034		DATE 02/09/2022	WEIGHT 0,008kg
	CODE CA.08.09.034				